













ROUND TABLE Assembly Instruction

PARTS LIST			QTY
A	TABLE RIM		1
B	GLASS TOP		1
C	TABLE LEG(1)		2
D	TABLE LEG(2)		1
E	BOLT(SHORT)		8
F	BOLT(LONG)		4
G	NUT		4
H	MATEL WASHER		16
I	BOLT PLASTIC CAP		12
J	PLASTIC NUT CAP		4
K	ALLEN WRENCH		1
L	HEX WRENCH		1
M	TOUCH UP PAINT BOTTLE		1

For warranty purpose or to buy replacement parts always keep this item number .

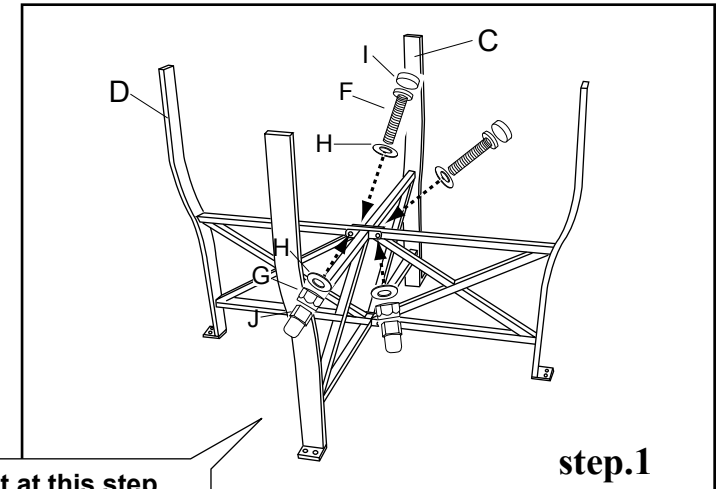

Do not fix too tight at this step.

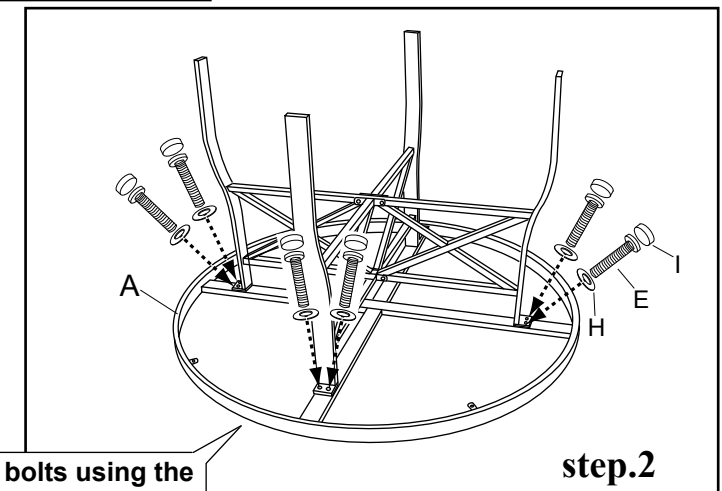

Now tighten all bolts using the Allen Wrench provided.

