

ASSEMBLY INSTRUCTION

ROUND 160 CM TABLE

FOR ROUND TABLE WITH FLAT WICKER

Part list

Please check to assure all items listed below available before assembly



→ A=2



→ B=2



→ C1=1





→ D1=1



→ E=2

HARDWARE LIST

①		M6 X 25	16
②		4 X L4	1

Assembly process
Step 1

Used with 16 pcs M6x25

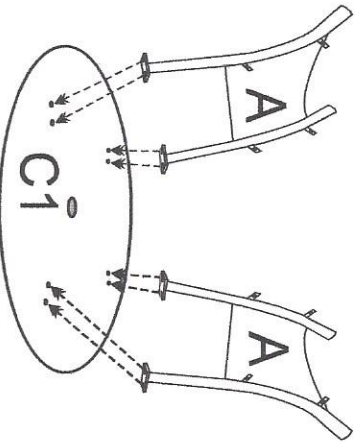

Attached Parts A to the table top insuring that the bolts are kept loose to insure that the side panels can be fitted

Step 2

Used with 16 pcs M6x25

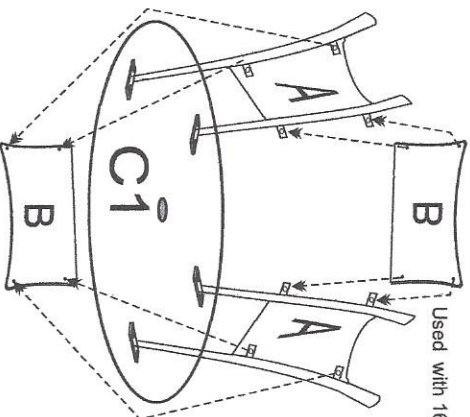

Attach part B to part A keeping all bolt loose

Step 3

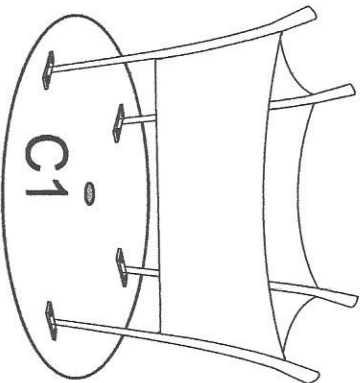

Tighten all bolts

Step 4

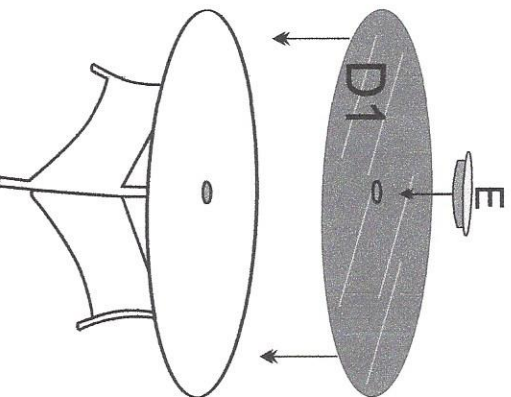

Place glass on top of table

Note :slightly twist all the screws by hand then tighten the screws by " L "