









# Assembly Instruction

## Part list:

No.	Picture	Name	Qty
A		Glass	1
B		Table Rim	1
C		Leg Connector	1
D		Table Leg	4
E		Pvc Bolt Cover	12
F		M6x30 Bolt	8
G		M6x15 Bolt	4
H		Steel Washer	12
I		Wrench	1

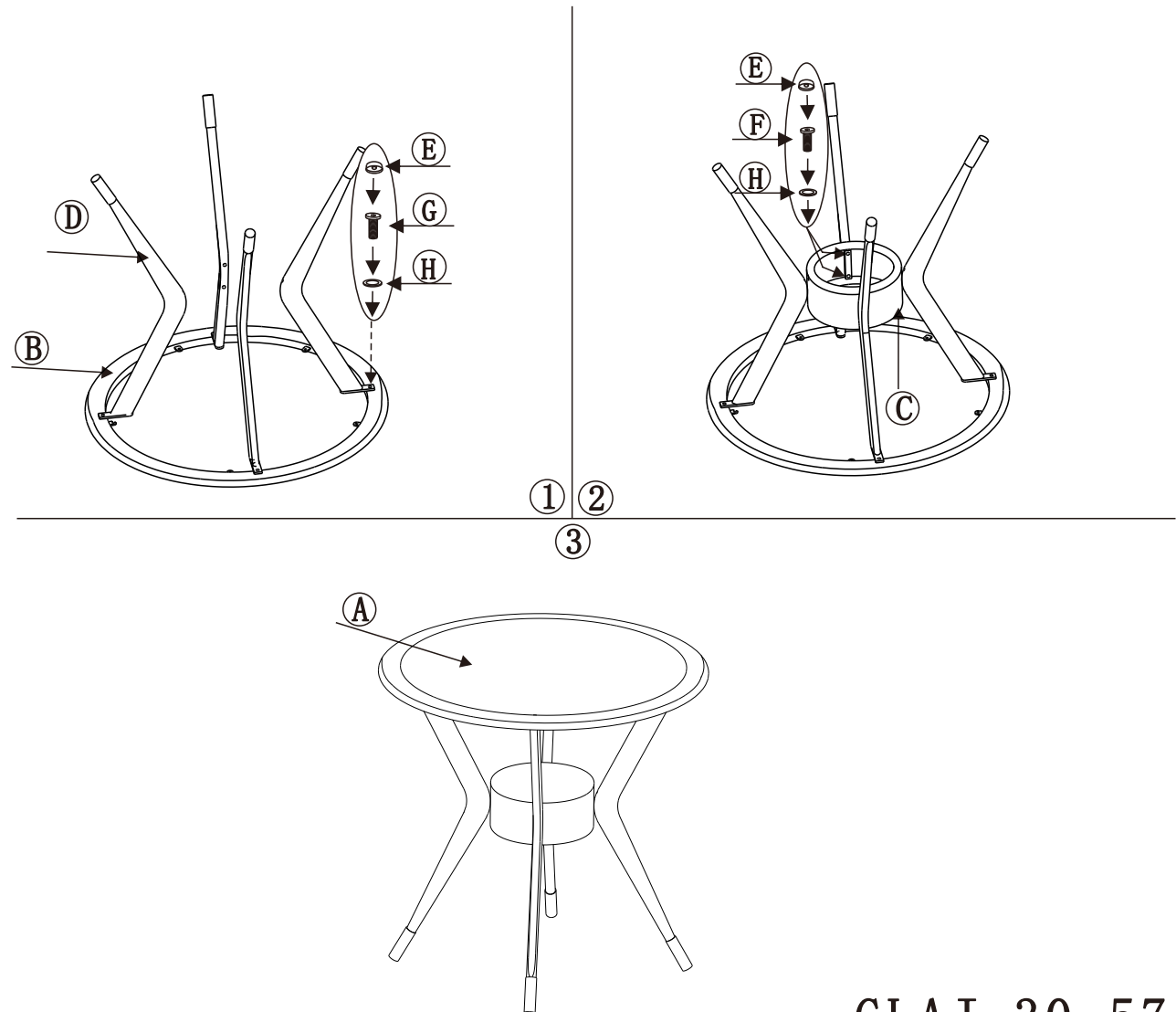

GLAJ-30-57