







Assembly Instruction

Parts list:

NO	PART LIST	DESCRIPTION	QTY
A		Back Frame	1
B		Seat Frame	1
C		Wrench	1
D		Bolt (45mm)	2
E		Steel Washer	2
F		Plastic Washer	2
G		Bolt Cover	2

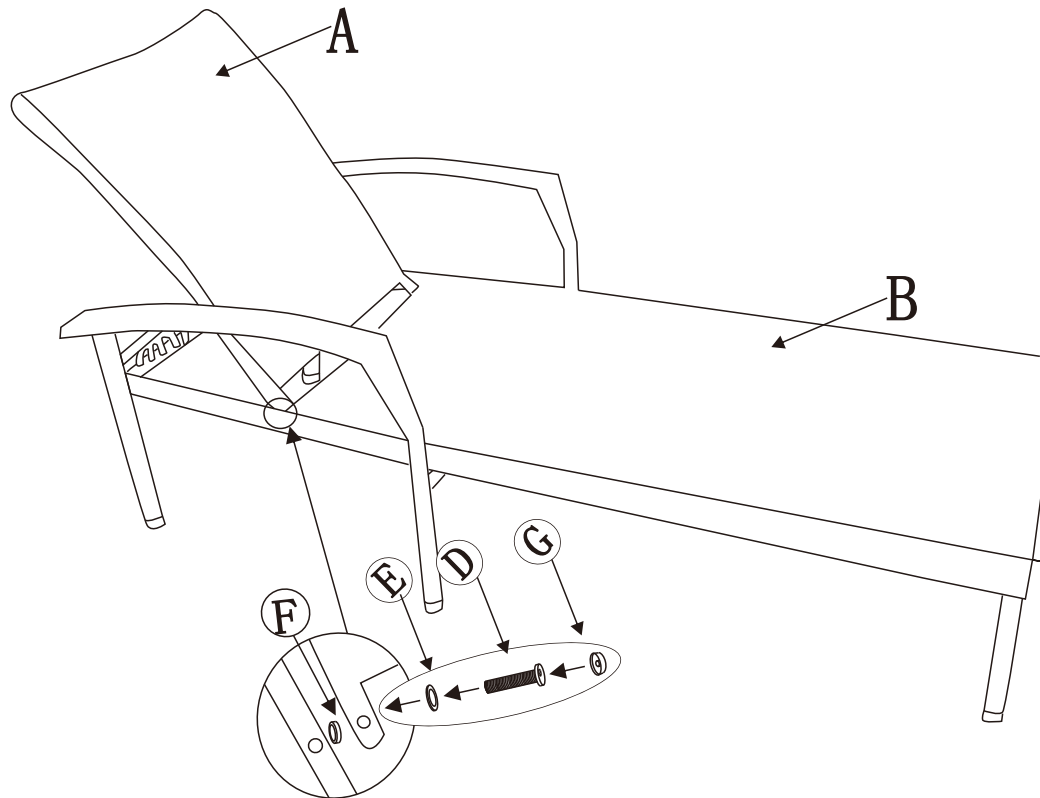

GLA-6615-14